

aiwa

Compact Disc Stereo System

XS-DS70

U

COMPACT
disc
DIGITAL AUDIO

For assistance and information

call toll free 1-800-BUY-AIWA

(United States and Puerto Rico)

8B-NCJ-903-01
010125AMI-U-M

OPERATING INSTRUCTIONS

En (English)

MANUAL DE INSTRUCCIONES

E (Español)

MODE D'EMPLOI

F (Français)

PRECAUTIONS

Read these Operating Instructions carefully and completely before operating the unit. All precautions on this booklet and on the unit should be strictly followed. Keep the Operating Instructions for future reference.

En

WARNING

To reduce the risk of fire or electric shock, do not expose this appliance to rain or moisture.



Explanation of Graphical Symbols:

The lightning flash with arrowhead symbol, within an equilateral triangle, is intended to alert the user to the presence of uninsulated "dangerous voltage" within the product's enclosure that may be of sufficient magnitude to constitute a risk of electric shock to persons.



The exclamation point within an equilateral triangle is intended to alert the user to the presence of important operating and maintenance (servicing) instructions in the literature accompanying the appliance.



Installation

- 1 Water and moisture** — Do not use this unit near water, such as near a bathtub, washbowl, swimming pool, or the like.
- 2 Heat** — Do not use this unit near sources of heat, including heating vents, stoves, or other appliances that generate heat. It also should not be placed in temperatures less than 5°C (41°F) or greater than 35°C (95°F).
- 3 Mounting surface** — Place the unit on a flat, even surface.
- 4 Ventilation** — The unit should be situated with adequate space around it so that proper heat ventilation is assured. Allow 10 cm (4 in.) clearance from the rear and the top of the unit, and 5 cm (2 in.) from each side.
 - Do not place the unit on a bed, rug, or similar surface that may block the ventilation openings.
 - Do not install the unit in a bookcase, cabinet, or airtight rack where ventilation may be impeded.
- 5 Objects and liquid entry** — Take care that objects or liquids do not get inside the unit through the ventilation openings.
- 6 Carts and stands** — When placed or mounted on a stand or cart, the unit should be moved with care. Quick stops, excessive force, and uneven surfaces may cause the unit or cart to overturn or fall.
- 7 Condensation** — Moisture may form on the CD pickup lens when:
 - The unit is moved from a cold spot to a warm spot
 - The heating system has just been turned on
 - The unit is used in a very humid room
 - The unit is cooled by an air conditionerWhen this unit has condensation inside, it may not function normally. Should this occur, leave the unit for a few hours, then try to operate again.
- 8 Wall or ceiling mounting** — The unit should not be mounted on a wall or ceiling, unless specified in the Operating Instructions.

Electric Power

- 1 Power sources** — Connect this unit only to power sources specified in the Operating Instructions, and as marked on the unit.
- 2 Polarization** — As a safety feature, some units are equipped with polarized AC power plugs which can only be inserted one way into a power outlet. If it is difficult or impossible to insert the AC power plug into an outlet, turn the plug over and try again. If it still does not easily insert into the outlet, please call a qualified service technician to service or replace the outlet. To avoid defeating the safety feature of the polarized plug, do not force it into a power outlet.
- 3 AC power cord**
 - When disconnecting the AC power cord, pull it out by the AC power plug. Do not pull the cord itself.
 - Never handle the AC power plug with wet hands, as this could result in fire or shock.
 - Power cords should be firmly secured to avoid being severely bent, pinched, or walked upon. Pay particular attention to the cord from the unit to the power outlet.
 - Avoid overloading AC outlets and extension cords beyond their capacity, as this could result in fire or shock.
- 4 Extension cord** — To help prevent electric shock, do not use a polarized AC power plug with an extension cord, receptacle, or other outlet unless the polarized plug can be completely inserted to prevent exposure of the blades of the plug.
- 5 When not in use** — Unplug the AC power cord from the power outlet if the unit will not be used for several months or more. When the cord is plugged in, a small amount of current continues to flow to the unit, even when the power is turned off.

Outdoor Antenna

- 1 Power lines** — When connecting an outdoor antenna, make sure it is located away from power lines.
- 2 Outdoor antenna grounding** — Be sure the antenna system is properly grounded to provide protection against unexpected voltage surges or static electricity build-up. Article 810 of the National Electrical Code, ANSI/NFPA 70, provides information on proper grounding of the mast, supporting structure, and the lead-in wire to the antenna discharge unit, as well as the size of the grounding unit, connection to grounding terminals, and requirements for grounding terminals themselves.

Antenna Grounding According to the National Electrical Code

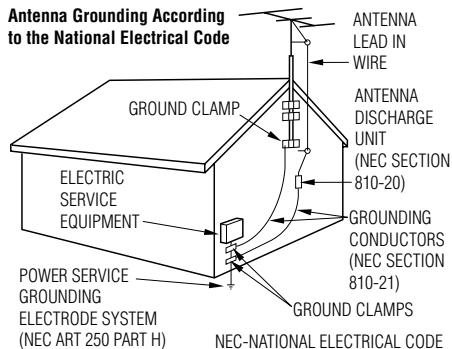

Maintenance

Clean the unit only as recommended in the Operating Instructions.

Damage Requiring Service

- Have the units serviced by a qualified service technician if:
- The AC power cord or plug has been damaged
 - Foreign objects or liquid have gotten inside the unit
 - The unit has been exposed to rain or water
 - The unit does not seem to operate normally
 - The unit exhibits a marked change in performance
 - The unit has been dropped, or the cabinet has been damaged
- DO NOT ATTEMPT TO SERVICE THE UNIT YOURSELF.

OWNER'S RECORD

Record the model number and serial number of your set (found at the rear of your set) below. Refer to them when contacting your Aiwa dealer.

Model No. _____

Serial No. _____

To attach the front speaker (marked "FRONT") to the pedestal

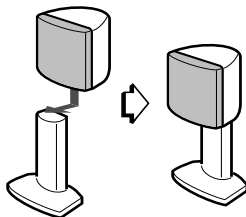

TABLE OF CONTENTS

PRECAUTIONS	2
PREPARATIONS	4
PARTS AND CONTROLS	7
ADJUSTMENTS BEFORE OPERATIONS	10
CD OPERATIONS	12
RADIO OPERATIONS	14
LISTENING TO EXTERNAL SOURCES	16
(Dolby Surround)	16
SOUND ADJUSTMENTS	20
TIMER OPERATIONS	21
REFERENCE	23

System and accessories

XS-DS70

CX-GDS70 Compact disc stereo receiver

SX-GDS70 Five Surround speakers system

Front speakers

Surround speakers

Center speaker

TS-WM5 Subwoofer

Remote control

FM antenna

AM antenna

Front speakers cords (approx. 4 m / 13.1 ft.) × 2

Surround speaker cords with plugs (approx. 8 m / 26.2 ft.) × 2

Center speaker cord with a plug (approx. 3 m / 9.8 ft.) × 1

PREPARATIONS

Connection

Plug in the AC power cord to the AC power outlet after all other connections are made.

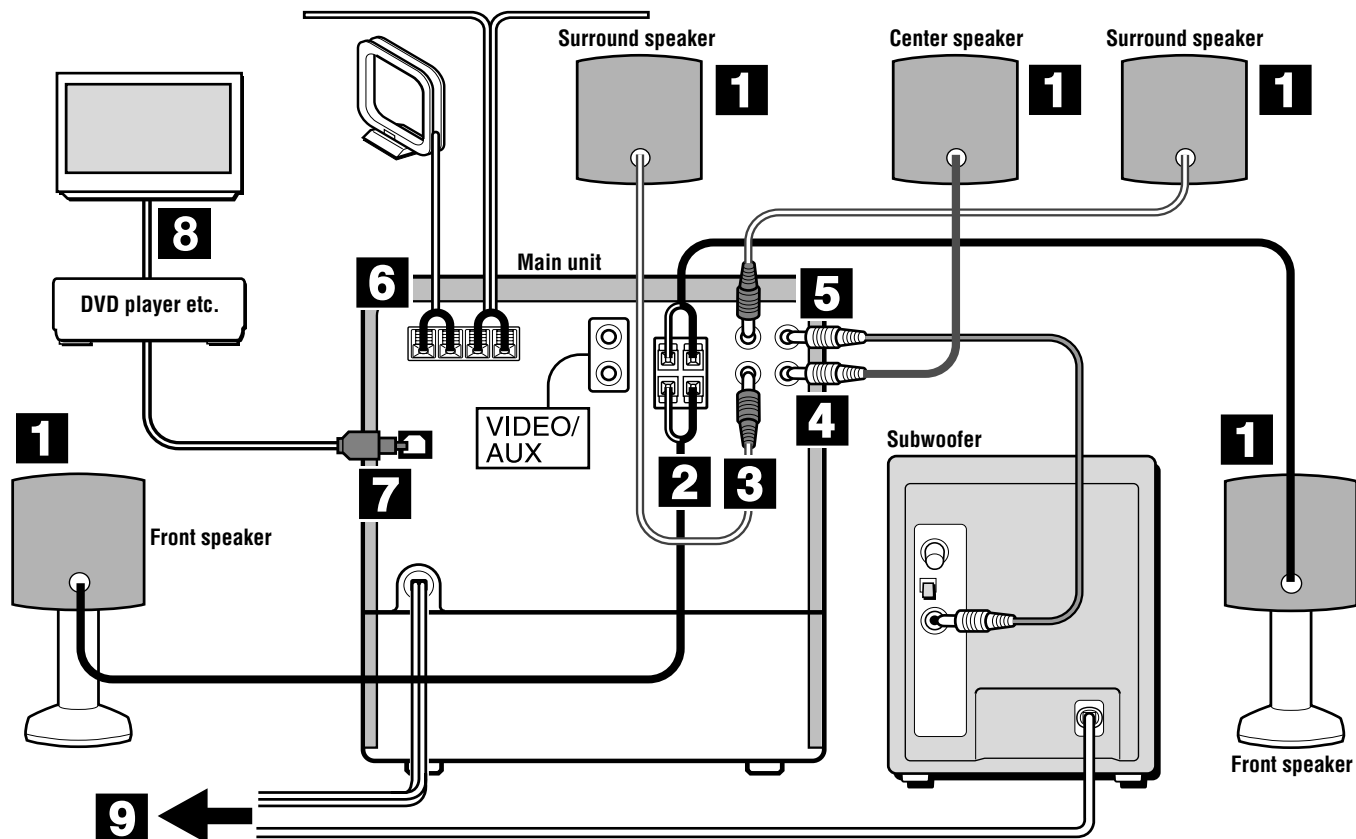

1 Connect the speaker cords to the front speakers, surround speakers and center speaker.

For the front speakers (marked "FRONT"), connect the ends of the stripe cords to the \oplus terminal and the ends of the other cords to the \ominus terminal with the front speakers cords (without a plug, approx. 4 m / 13.1 ft.).

For the surround speakers (marked "REAR"), connect the ends of the stripe cords to the \oplus terminal and the ends of the other cords to the \ominus terminal with the surround speaker cords (with plugs, approx. 8 m / 26.2 ft.).

For the center speaker (marked "CENTER"), connect the end of the stripe cord to the \oplus terminal and the end of the other cord to the \ominus terminal with the center speaker cord (with a plug, approx. 3 m / 9.8 ft.).

2 Connect the front speakers.

Connect the right front speaker to the FRONT SPEAKERS R terminals and the left to the FRONT SPEAKERS L terminals. The speaker cords with the white stripes go to the \oplus terminals.

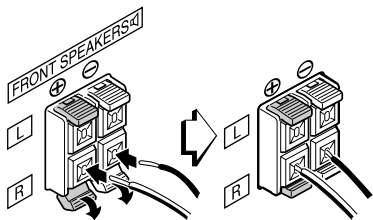

3 Connect the surround speakers.

Connect each surround speaker cord to the SURROUND SPEAKERS R jack or the SURROUND SPEAKERS L jack.



4 Connect the center speaker.

Connect the center speaker cord to the CENTER SPEAKER jack.



5 Connect the subwoofer.

Connect the subwoofer cord to the SUB WOOFER jack.

- Refer to the Operating Instructions of TS-WM5 for the details.

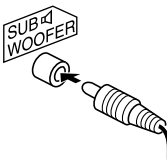

6 Connect the supplied antennas.

Connect the FM antenna to the FM 75 Ω terminals and the AM antenna to the AM LOOP terminals.

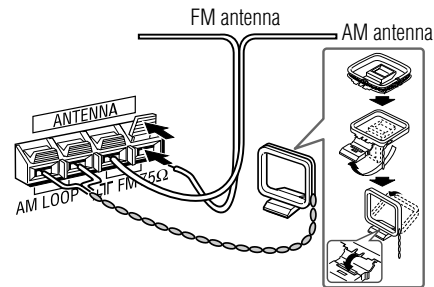

7 Connect the video equipment (DVD player, LD player, video tape player, etc.).

If the video equipment has an OPTICAL OUT jack: Remove the dust cap (a) from the DIGITAL IN (PCM/DOLBY DIGITAL) OPTICAL (VIDEO) jack of this unit. Then, connect the OPTICAL OUT jack to the DIGITAL IN (PCM/DOLBY DIGITAL) OPTICAL (VIDEO) jack with an optional optical connecting cord.

Tip:

To activate the spectrum analyzer, connect the digital equipment also by analog connection to the VIDEO/AUX jacks (see below).

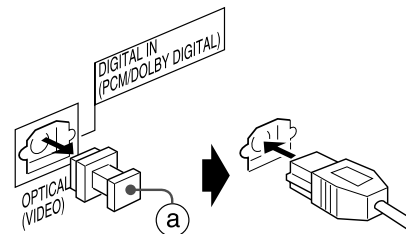

If the video equipment does not have a digital out jack: Connect the AUDIO OUT jacks of the video equipment to the VIDEO/AUX jacks of this unit with an optional audio connecting cord with RCA phono plugs (red plug to the R jack, white plug to the L jack).

- When connecting an LD player via its AC-3 RF OUT jack, use an RF demodulator to separate the analog visual signals and the digital audio signals. Refer to the Operating Instructions of the LD player.

8 Connect the television to the video equipment. Refer to the Operating Instructions of the connected equipment for details.

9 Connect the AC power cord to an AC outlet. When the AC power cord is connected to an AC outlet for the first time, DEMO appears on the display. To deactivate the DEMO, press DEMO/ECO.

- Do not short-circuit the \oplus and \ominus speaker cord leads.
- Do not leave objects generating magnetism or objects affected by magnetism near the speakers.

Note on positioning

Allow 10 cm (4 in.) clearance from the top of the unit for the Window movement when you position the unit.

Positioning the speakers

To achieve the optimum effects obtainable with the Dolby Digital or the Dolby Pro Logic system, it is important to position the speakers properly. Refer to the following illustration to find out the best location in your room.

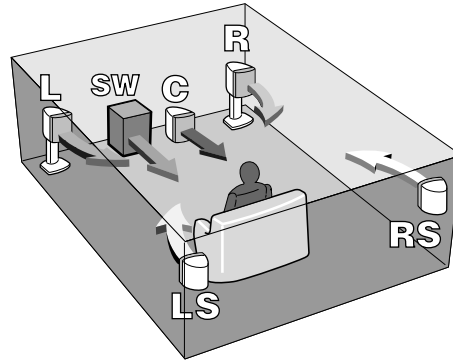

L&R: Front speakers

C: Center speaker

Position in the center of the two front speakers. In addition, position on or below the TV set, if connecting a TV set to the unit.

LS&RS: Surround speakers

Place the surround speakers directly to the side of or slightly behind the listening area. Align them horizontally, about 1 meter (3.2 feet) above ear height.

SW: Subwoofer

Place the subwoofer on the floor close to a wall or in a corner of the room.

- Sound output from the center and the surround speakers is only available when the Dolby Digital system or the Dolby Pro Logic system is activated with the appropriate setting.

To mount the surround speakers on the wall

Mount each speaker on a spot that can hold its weight.

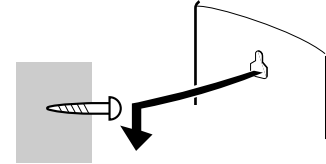

AIWA disclaims any responsibility for injury to persons or other accidents caused by not fitting the surround speakers properly or if the place of the installation is not suitable.

Remote control

Detach the battery compartment lid at the rear of the remote control and insert two R6 (size AA) batteries with correct polarity.

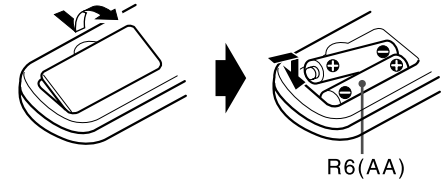

- Replace the batteries with new ones when the operational distance between the remote control and main unit becomes shorter.
- Remove the batteries if the unit is not going to be used for an extended period of time.
- The remote control may not operate if it is used under intense sunlight, etc., or if its line of sight is obstructed.

PARTS AND CONTROLS

Main unit: rear

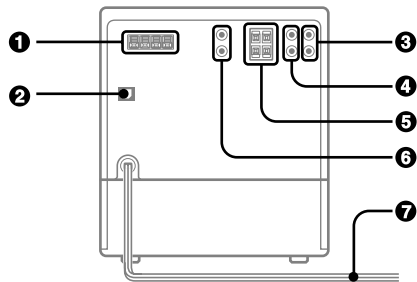

- ❶ AM LOOP, FM 75 Ω terminals**
Plug in the supplied AM and FM antennas here.
- ❷ DIGITAL IN (PCM/DOLBY DIGITAL) OPTICAL (VIDEO) jack**
Accepts Dolby Digital signals as well as PCM signals (conventional digital audio signals, used, for example, in audio CDs) from external digital equipment. When this jack is not being used, attach the supplied dust cap.
- ❸ SUB WOOFER \square jack**
Connect the speaker cord of the supplied subwoofer or an optional powered subwoofer with a built-in amplifier here.
- CENTER SPEAKER \square jack**
Connect the speaker cord of the supplied center speaker here.
- ❹ SURROUND SPEAKERS \square jacks**
Connect the speaker cord of the supplied surround speakers here.
- ❺ FRONT SPEAKERS \square terminals**
Connect the speaker cord of the supplied front speakers here.
- ❻ VIDEO/AUX jacks**
Accepts analog sound signals from external equipment.
- ❼ AC power cord**

Dynamic Integrated Neo Amplifier

Is a brand-new amplifier system where clear mid-to-high range frequency sound, as well as rich low frequency sound, can be reproduced and listeners can enjoy the close-to-original sound with less distortion at either high or low volume levels.

En

Main unit: front

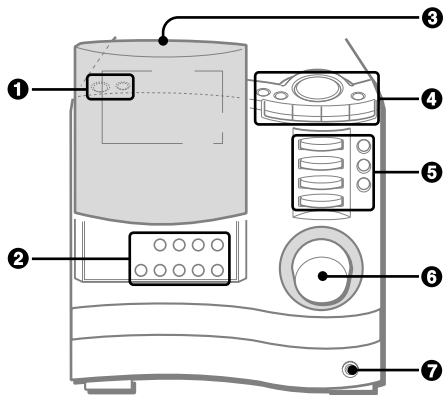

1 POWER STANDBY/ON

Switches the unit on and off (standby).

DEMO/ECO

When the unit is turned off: switches DEMO on and off.
When the unit is turned on: enters ECO setting mode.

2 NORMAL

Selects NORMAL mode for Dolby Surround.

PHANTOM

Selects PHANTOM mode for Dolby Surround.

3 STEREO

Selects 3 STEREO mode for Dolby Surround.

DIGITAL/ANALOG

Selects digital input (DIGITAL IN (PCM/DOLBY DIGITAL) OPTICAL (VIDEO) jack) or analog input (VIDEO/AUX jacks) only when VIDEO/AUX/DVD function is selected.

▶ PRESET

CD: starts playback.
Radio: tunes into a preset station.

■ CLEAR

CD: stops playback.
Radio: clears a station preset.

|| SET

CD: pauses playback.
Radio: stores the received station to preset.

◀◀/|◀DOWN, ▶▶/|▶UP TUNING

CD: skips to a previous or a succeeding track when pressed, searches a track in fast forward or fast reverse playback when held down.
Radio: manually tunes down or up within the band.

3 Motorized Slide Window

Moves up and down.
Referred to as "Window" in these Operating Instructions.

4 SOUND MODE

Selects T-BASS, BBE or GEQ mode.

FUNCTION MODE

Selects DISPLAY color, TIMER or WINDOW (AUTO or MANUAL for the WINDOW up/down) mode.

MULTI JOG

CD: skips to a previous or succeeding track.
Radio: selects a preset number.
Clock and time: sets the time.
SOUND MODE, FUNCTION MODE and ECO: selects the mode.

ENTER

Determines the mode and the time (FUNCTION MODE, ECO, clock and timer)

DISC DIRECT PLAY 1-3

Selects a CD tray.

DISC CHANGE

Rotates the CD trays.

5 FM

Selects FM band of Radio function.

AM

Selects AM band of Radio function.

VIDEO/AUX/DVD

Selects the function of external equipment connected to DIGITAL IN (PCM/DOLBY DIGITAL) OPTICAL (VIDEO) jack or VIDEO/AUX jacks.

CD

Selects CD function.

▲ CD OPEN/CLOSE

Opens or closes the disc compartment.

WINDOW UP

Moves the Window up.

WINDOW DOWN

Moves the Window down.

6 VOLUME

Adjusts the volume.

7 PHONES jack

Plug in here an optional headphones set with a standard stereo plug (ø6.3 mm). Speaker output is canceled.

Remote control

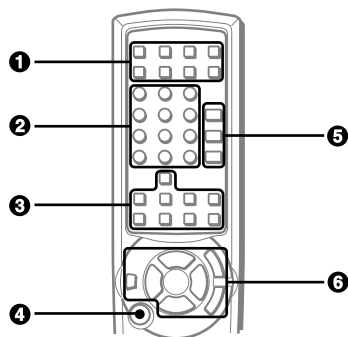

Buttons with same or similar names with the main unit basically have the same function.

❶ WINDOW DOWN

WINDOW UP

REMAIN

Displays the remaining playback time of a CD when pressed during playback.

PRGM

Enters programmed CD playback mode.

TIMER

Enters timer setting mode.

SLEEP

Enters sleep-timer setting mode.

CLOCK

Enters clock adjustment mode.

RANDOM/REPEAT

Enters random or repeat CD playback mode.

❷ 0-9, +10

CD: selects a CD track of the specified number.
Radio: tunes in to the station with the specified preset number.

CD DIRECT

Selects a CD tray with the numbered button (1-3).

❸ MONO TUNER

Switches between stereo or monaural FM reception.

T-BASS

Emphasizes low frequency sound.

GEQ

Selects a sound equalization curve.

SURROUND

Selects a Dolby Surround mode.

MANUAL SELECT

Adjusts speaker level or delay time.

CENTER LEVEL (+, -)

Adjusts the sound level of the center speaker for Dolby Surround.

REAR LEVEL (+, -)

Adjusts the sound level of the surround speakers for Dolby Surround.

❹ POWER

❺ TUNER/BAND

Selects Radio function and the radio band.

VIDEO/AUX

CD

❻ II SET

▶ PRESET

◀◀/|◀◀DOWN, ▶▶/▶▶IUP TUNING

■ CLEAR

VOL(∧, ∨)

En

ADJUSTMENTS BEFORE OPERATIONS

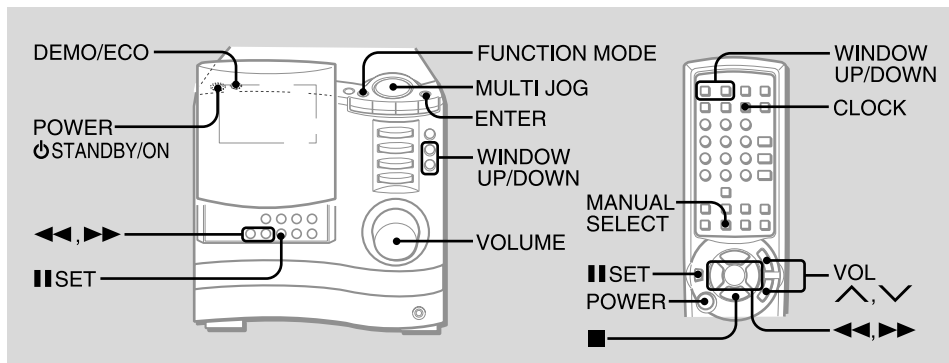

En

Power

Turning the unit on

Press POWER ⏻ STANDBY/ON (POWER on the remote control).

Or press FM, AM, VIDEO/AUX/DVD or CD, the playback will start automatically if a disc or tape is inserted.

Turning the unit off

Press POWER ⏻ STANDBY/ON again.

The unit goes into standby.

Volume

Turn VOLUME (Press VOL ^, v on the remote control).

Adjust from 0 (minimum) to 49 and MAX (maximum).

Tip:

Volume level setting is retained during power-off standby. If the unit is turned off with the volume set to 21 or more, it is automatically turned down to 20 the next time the unit is turned on.

To change the left/right balance

Press MANUAL SELECT repeatedly on the remote control until "L/R" is displayed. Then, press ◀ or ▶ within 4 seconds.

- The front speaker level for the Dolby Digital and Dolby Pro Logic systems is changed as well.

DEMO

If the clock has not been set, a DEMO appears on the display when the unit is turned off.

To deactivate and activate the DEMO

Press DEMO/ECO.

Motorized Slide Window

Reveals and covers the operation buttons.

To move the Window up/down

Press Window UP or WINDOW DOWN.

To select AUTO or MANUAL mode

- 1 Press FUNCTION MODE repeatedly until "WINDOW" is displayed.
- 2 Turn MULTI JOG to select "AUTO" or "MANUAL" and then press ENTER.
If there is no MULTI JOG operation within 4 seconds, the setting is canceled.

AUTO mode

- The Window moves up and down automatically. e.g.) It moves up when CD function is selected (CD is pressed).

MANUAL mode

- The Window moves up and down as you operate with WINDOW UP or WINDOW DOWN.

To display the current mode

Press FUNCTION MODE repeatedly until "WINDOW" is displayed and then press ENTER within 4 seconds. The mode will be displayed for 4 seconds.

Note on WINDOW

Do not place anything on the top of the Window (on the top of the unit).

ECO mode

Reduces power consumption with the following operations, etc.

ECO ON mode

- The unit blacks out when the unit is turned off. Only the red indicator lights up. (Only when the clock is set.)

ECO AUTO mode

- In addition to the operations of ECO ON mode, the unit automatically turns itself off if you do not operate the unit and the sound source is mute for 10 minutes.

- 1 Press DEMO/ECO once when the unit is turned on.
- 2 Turn MULTI JOG to select one of the ECO modes and then press ENTER.
If there is no MULTI JOG or button operation within 4 seconds, the setting is canceled.

To cancel the ECO mode

Repeat the above and select "ECO OFF".

Display color

The display color can be changed.

- 1 Press FUNCTION MODE once so that "DISPLAY" is displayed.
- 2 Turn MULTI JOG to select a color and then press ENTER.
If there is no MULTI JOG operation within 4 seconds, the setting is canceled.

Setting the clock

- 1 Press CLOCK on the remote control.
- 2 Press ◀◀ or ▶▶ to set the time.
Each press changes the time in 1-minute steps. Holding it down changes the time in 10-minute steps.
If ◀◀ or ▶▶ is not pressed within 4 seconds, setting is canceled.
• MULTI JOG is also available in place of ◀◀ or ▶▶.
- 3 Press ENTER or ■■SET.
The time display stops flashing and the clock starts from 00 seconds.

To display the time

Press CLOCK on the remote control.
The time will be displayed for 4 seconds.

To switch to the 24-hour standard

Display the time and press ■ within 4 seconds.
With each press, the clock alternates between the 12-hour standard and the 24-hour standard.

Tip:

In the 12-hour standard, "AM 12:00" indicates midnight and "PM 12:00" noon.

If the clock display flashes when the unit is turned off

There has been a power interruption. Re-set the clock.



As an ENERGY STAR® Partner, AIWA has determined that this product meets the ENERGY STAR® guidelines for energy efficiency.

CD OPERATIONS

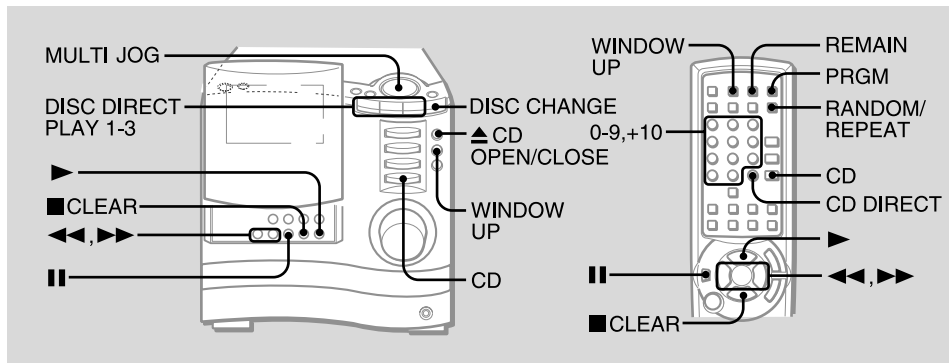

This unit plays back finalized CD-R/RW discs as well as audio CDs.

* Move the Window up to reveal the operation buttons with WINDOW UP if needed.

Playback

1 Press CD and load disc(s)

Press **▲ CD OPEN/CLOSE** to open the disc compartment and place one or two disc(s) with the labeled side up. To place three discs, press **DISC CHANGE** so that the trays rotate, then place the third one. Lastly, close the compartment with **▲ CD OPEN/CLOSE**.

- When loading an 8-cm (3-inch) disc, place it on the inner circle of the tray.

2 To play all discs, press **▶**.

To play one desired disc, press **DISC DIRECT PLAY 1-3**.

To stop playback

Press **■**.

To pause playback

Press **||**. Press again to resume playback.

To skip to the beginning of the current/preceding succeeding track

Press **◀◀** or **▶▶** repeatedly or turn **MULTI JOG**.

To search (playback in fast forward or fast reverse)

Hold down **◀◀** or **▶▶**. Release at the desired point.

To select a disc and a track with the remote control

1 Press **CD DIRECT**, and then press the numbered button (1-3) within 3 seconds to select a disc.

2 Press the numbered buttons to select a track.

- To select track 25, press +10, +10 and 5.

- To select track 10, press +10 and 0.

To display the remaining playback time of the CD

Press **REMAIN** on the remote control. Press again to return to the elapsed time display.

- Remaining playback time cannot be displayed during random playback or programmed playback.

To replace disc(s) during playback without interruption

While one disc is being played back, press **DISC CHANGE** so that the compartment opens, replace disc(s) with other one(s), and press **DISC CHANGE** to close the compartment.

Random/Repeat playback

Random playback plays all the tracks on one desired disc or all the discs in random order. Repeat playback plays all the tracks repeatedly on one desired disc or all the discs.

1 Press **RANDOM/REPEAT** repeatedly on the remote control to select one of the following modes:

- Random playback: "**RANDOM**" lights up.

- Repeat playback: "**↺**" lights up.

- Random and repeat playback: "**RANDOM**" and "**↺**" lights up.

2 To play one desired disc, press **DISC DIRECT PLAY 1-3**.

To play all discs, press **▶**.

To cancel random/repeat playback

Press **RANDOM/REPEAT** repeatedly on the remote control so that both "**RANDOM**" and "**↺**" disappear on the display.

To repeat a selected set of tracks

Select the tracks with programmed playback, then press **RANDOM/REPEAT** on the remote control to select repeat playback.

- It is impossible to play a selected set of tracks in random order.

Programmed playback

Plays back up to 30 selected tracks in programmed order.

- 1 Press PRGM on the remote control during stop. "PRGM" lights up on the display.
- 2 Press DISC DIRECT PLAY 1-3 to select a disc. Go to the next step when the tray stops rotating.
- 3 Press the numbered buttons on the remote control to program a track.
The selected track number lights up on the display.
-To select the 25th track, press +10, +10 and 5.
-To select the 10th track, press +10 and 0.
- 4 Repeat step 2 and 3 to program other tracks.

5 Press ►.

- During programmed playback, you cannot select a disc or a track with the numbered buttons. "CAN'T USE" is displayed when you try to select a track.
- If the total playback time of the program exceeds 99:59 minutes, or if a track with a track number exceeding 30 is programmed, the playing time is displayed as "- :- -".
- You cannot program more than 30 tracks. "FULL" is displayed.

To check the program

Press ◀◀ or ▶▶ repeatedly during stop. The disc number flashes, and the track number and program number are displayed in succession.

To clear the program

Press ■ CLEAR during stop. "PRGM" disappears on the display.

To add tracks to the program

Repeat step 2 and 3 before starting playback. The tracks are added to the end of the program.

To change the programmed tracks

Clear the program and reselect the tracks in your desired order.

Notes on CDs

- Do not place more than one disc on one tray.
- Do not tilt the unit with discs loaded.
- The unit may not play a CD-R/RW disc recorded on personal computers or certain kinds of CD-R/RW recorders.
- Do not attach adhesive label, etc. to either side of a CD-R/RW disc, as doing so may cause malfunction.
- Do not load an unrecorded CD-R/RW disc. The disc may be damaged.
- Do not use irregular-shaped CDs.

RADIO OPERATIONS

En

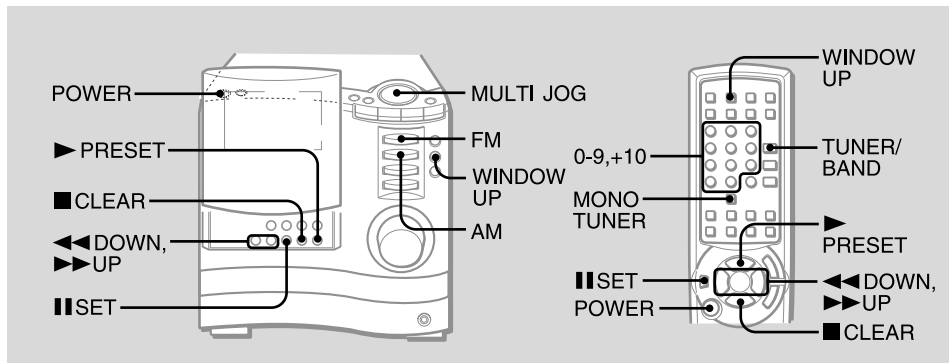

* Move the Window up to reveal the operation buttons with WINDOW UP if needed.

Manual tuning

- 1 Press FM or AM (TUNER/BAND on the remote control) to select a band (FM or AM).
The unit switches to the radio from any other function.
- 2 Press ◀◀DOWN or ▶▶UP to tune in to a station.
"TUNE" is displayed when a station is tuned in.
"((◉))" lights up for FM stereo reception.

To search for a station automatically (Auto Search)

Hold down ◀◀DOWN or ▶▶UP.

The unit searches for a station up or down the band and stops at reception.

To stop the search manually, press ◀◀DOWN or ▶▶UP.

- Auto Search may not stop at stations with weak signals.

Preset tuning

Preset your favorite stations and tune them in directly.

Presetting stations

- 1 Press FM or AM to select the band.
 - 2 Press ◀◀DOWN or ▶▶UP to tune in to the desired station.
 - 3 Press ■■SET to store the station.
The preset number, beginning from "1", appears on the display.
 - 4 Repeat step 1 to 3 to preset other stations.
- You cannot store more than a total of 32 preset stations.
"FULL" is displayed.

Tuning in to preset stations

On the unit

- 1 Press FM or AM to select the band.
- 2 Press ▶PRESET repeatedly or turn MULTI JOG.
With each press, the station with the succeeding preset number is tuned in.

On the remote control

- 1 Press TUNER/BAND to select the band.
- 2 Press the numbered buttons for the preset number of your desired station.
 - To select preset number 20, press +10, +10 and 0.
 - To select preset number 15, press +10 and 5.

To clear a preset station

- 1 Tune in to the station by preset tuning.
- 2 Press ■CLEAR, then press ■■SET within 4 seconds.
Preset numbers of preset stations in the band with higher numbers decrease by one.

Adjustments

Antennas

Keep antennas away from metallic objects, electrical equipment and cords.

FM antenna: Extend fully in a T-shape. If receiving condition is poor, connect optional outdoor antenna to FM 75 Ω terminal. Be sure to connect the shield braid of the antenna to the  terminal.

AM antenna: Rotate to find best reception.

To switch to monaural FM reception

Press MONO TUNER on the remote control. With each press, "MONO" and "STEREO" are displayed alternately on the display.

Tip:

When FM stereo reception is poor, switching to monaural reduces noise.

To switch the AM tuning interval

Hold down AM and press POWER. With each press, the AM tuning interval alternates between 9 kHz/step and 10 kHz/step.

Tip:

The default is 10 kHz/step. Change it only when using the unit in a 9 kHz/step area. Switching AM tuning interval clears all the preset stations.

LISTENING TO EXTERNAL SOURCES

En

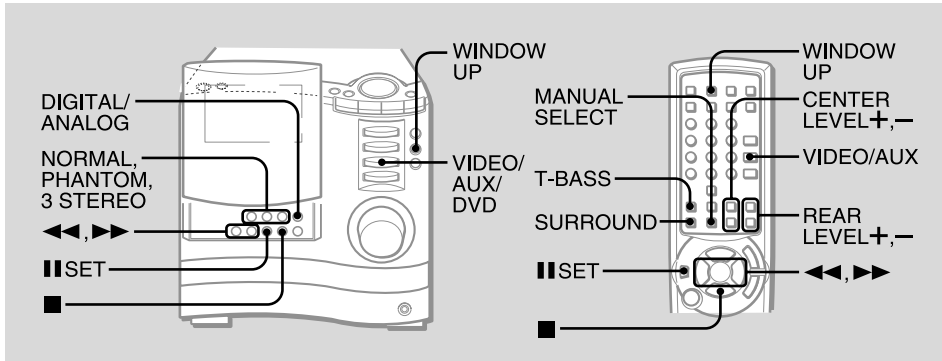

* Move the Window up to reveal the operation buttons with WINDOW UP if needed.

Playing a digital source

(Playing equipment connected to the DIGITAL IN (PCM/DOLBY DIGITAL) OPTICAL (VIDEO) jack)

- 1 Select digital input.
Press VIDEO/AUX/DVD and then press DIGITAL/ANALOG to select "DIGITAL".
The "DIGITAL" indicator lights up on the display.
- 2 Play the connected equipment.
 - When digital input is selected, the BBE system is automatically canceled.

To change the displayed source name

Hold down VIDEO/AUX/DVD and press POWER when the unit is turned on. Repeat the procedure to select "VIDEO", "AUX" or "DVD".

Playing an analog source

(Playing equipment connected to the VIDEO/AUX jacks)

- 1 Select analog input.
Press VIDEO/AUX/DVD and then press DIGITAL/ANALOG to select "ANALOG"
- 2 Play the connected equipment.

To adjust the sound level of the external analog source

When the analog signal input from the connected equipment is too high, "OVERLEVEL" lights up continuously on the display.

When this occurs, or when the sound level is much lower than that of other function sources, adjust the sound level.

- 1 Select analog input and play the equipment.
- 2 Press ◀◀ or ▶▶ so that the sound level becomes the same as that of other function sources.

Dolby Surround

With this unit's built-in Dolby Digital decoder, video software recorded in Dolby Digital or Dolby Pro Logic can be played back in home theater sound.

Dialogs are heard in the front and center sound field, while ambient sounds like cars and crowds are reproduced on all sides of the listener, all in all for an incredibly lifelike audio-visual experience.

Dolby Pro Logic has four independent channels: left, center, right, and surround. These four channels are encoded into the two tracks of a conventional stereo program source. This unit's Dolby Digital decoder recovers these four channels on playback. Dolby Pro Logic software is marked with the  logo.

Dolby Digital, in contrast to Dolby Pro Logic, is digitized, and has separate left and right surround channels plus an additional low-frequency effects (LFE) channel. Thus it is also referred to as "5.1-channel" Dolby Digital, with the LFE channel counted as "0.1" channel.

Dolby Digital software is marked with the  logo.

Notes on Dolby Surround

- Dolby Digital sound and Dolby Pro Logic sound can only be obtained when playing back software with their respective logos.
- Make sure all the supplied speakers are placed and connected properly (see "Positioning the speakers").
- Make sure the video equipment can play back the particular medium of the Dolby Digital or Dolby Pro Logic software (LDs or DVDs, for example). Consult the operating instructions for the equipment. You cannot play DVDs on the unit's CD player.
- External digital input of this unit accepts Dolby Digital bitstream signals, or linear PCM signals with a sampling frequency of 32 kHz, 44.1 kHz or 48 kHz. This unit cannot play software whose sampling frequency is 96 kHz.
- Some DVD players connected digitally to this unit may cause noise during some DVD operation such as when searching a disc, skipping a chapter, etc.
- This unit does not support the DTS Digital Sound system.

Playing Dolby Surround sound

Playing Dolby Digital sound

For software with the  logo.

- 1 Select digital input. (See "Playing a digital source")
The "DIGITAL" indicator lights up on the display.
- 2 Play the Dolby Digital source on the video equipment.
The "DIGITAL" indicator lights up on the display.
 - If Dolby Digital software is played back via the analog connection, the sound will be in Dolby Pro Logic.
 - Dolby Digital mode is automatically changed to 2CH ST mode (see below) when the headphones are plugged in.

Playing Dolby Pro Logic sound

For software with the  logo.

- 1 Select analog input. (See "Playing an analog source")
- 2 Play the Dolby Pro Logic source on the video equipment.
- 3 Press NORMAL, PHANTOM or 3 STEREO to select one of the Dolby Surround modes (see below).
On the remote control, press SURROUND repeatedly.
The "PRO LOGIC" indicator lights up on the display.
 - Dolby Pro Logic sound is automatically canceled when the headphones are plugged in.
 - When Dolby Pro Logic is activated, the BBE system is automatically canceled.

To cancel Dolby Pro Logic

Press NORMAL, PHANTOM or 3 STEREO twice or press SURROUND on the remote control repeatedly to select "OFF".

Dolby Surround modes

Selects a Dolby Surround mode to match the connected speaker for playing Dolby Digital and Dolby Pro Logic sound

Press NORMAL, PHANTOM or 3 STEREO to select one of the following modes.

- NORMAL: When all speakers are connected.
- PHANTOM: When the center speaker is not connected. The center channel signals are output through the front speakers.
- 3 STEREO: When the surround speakers are not connected. The rear channel signals are output through the front speakers.
- 2CH ST (Dolby Digital) or OFF (Dolby Pro Logic): When neither the center nor the surround speaker units are connected. When 2CH ST mode is selected, "STEREO" appears on the display.

- Dolby Digital modes can only be selected when a Dolby Digital source is being played via digital connection.
- When playing 2-channel Dolby Digital sound that is not Pro Logic encoded, Dolby Pro Logic is activated instead of Dolby Digital.

To select with the remote control

Press SURROUND repeatedly to select one of the mode above.

To display the current Dolby Surround mode

Press SURROUND on the remote control once.

The mode will be displayed for 4 seconds.

Subwoofer On or Off mode

If you connect a subwoofer to this unit, change the Subwoofer mode to "S-W ON". Low-frequency effect signals are sent to the subwoofer. In "S-W OFF", low-frequency effect signals are directed to the other speakers.

- 1 Play the Dolby Surround sound.
 - 2 Press MANUAL SELECT on the remote control. "S-W OFF" or "S-W ON" is displayed.
 - 3 Press ◀◀ to display "S-W OFF" or ▶▶ to display "S-W ON" to select the desired mode.
- Subwoofer mode setting is common to Dolby Digital and Dolby Pro Logic.

Adjustments

Speaker level adjustment

The unit is equipped with a built-in test signal generator for easy balance adjustment of the channels. The test signal "travels" from channel to channel. Adjust the sound level for the same apparent loudness from each channel at listening position.

The left and right front speakers create the stereo effect.

The center speaker helps achieve precise sound positioning over a broad sound field.

The surround speakers enhance the "depth" of the sound field.

- 1 Press NORMAL, PHANTOM or 3 STEREO to select the mode for the speaker configuration (see "Dolby Surround modes").
On the remote control, press SURROUND repeatedly.
- For playback with the supplied speakers, select "NORMAL".
- 2 Hold down MANUAL SELECT on the remote control until "L" flashes in the display.
The indication for the currently adjustable channel flashes in the display and the test signal automatically cycles through the following channels:
- L: The left front speaker
- C: The center speaker
- R: The right front speaker
- RS: The right surround speaker
- LS: The left surround speaker
- 3 Press ◀◀ or ▶▶ on the remote control to adjust the sound level.
- *For the left and right front speakers:* Press ◀◀ to shift the balance to the left and ▶▶ to shift to the right.
- *For the center and the surround speakers:* Press ◀◀ to de-emphasize the channel and ▶▶ to emphasize the channel.

- The channel will not change while you are adjusting the sound level.
- Speaker level adjustment is available only for speakers that are activated.
- Adjustment of speaker levels is common to Dolby Digital and Dolby Pro Logic.
- A clicking sound might be heard with the test signal during level adjustment. This is due to the circuit characteristics and is not a malfunction.

To stop speaker level adjustment

Press ■.

To adjust the speaker level without the test signal

- 1 Play the Dolby Surround sound.
- 2 Press NORMAL, PHANTOM or 3 STEREO to select the mode for the speaker configuration.
On the remote control, press SURROUND repeatedly.
- 3 Press MANUAL SELECT repeatedly on the remote control until "L/R" is displayed.
- 4 Press ◀◀ or ▶▶ to adjust the sound level of the front speakers.
- 5 Repeat steps 3 and 4 to adjust the sound level of the other speakers.

To adjust the center speaker level directly on the remote control

- 1 Play the Dolby Surround sound.
- 2 Press SURROUND repeatedly to select "NORMAL" or "3 STEREO".
- 3 Press CENTER LEVEL + or -.

To adjust the rear (surround) speaker level directly on the remote control

- 1 Play the Dolby Surround sound.
- 2 Press SURROUND repeatedly to select "NORMAL" or "PHANTOM".
- 3 Press REAR LEVEL + or -.

- You cannot adjust the surround speaker level for LS and RS channels separately. To do that, see "To adjust the speaker level without the test signal".

Low-frequency effect level adjustment

Dolby Digital has a discrete channel for LFE (low-frequency effects), which reproduces sounds such as explosions and rumbles in movie soundtracks with astonishing realism.

- 1 Play the Dolby Digital sound.
 - 2 Hold down T-BASS on the remote control until "LFE" is displayed.
 - 3 Press ◀◀ or ▶▶ repeatedly to adjust the LFE level.
Adjust between OFF and -20 dB to 0 dB (maximum effect) in 5 dB steps. The default is "LFE 0".
- LFE is not available for Dolby Pro Logic.

Delay time adjustment

Sounds from the surround speakers or the center speaker are reproduced a split second after the front speakers for the effect of "depth".

- 1 Play the Dolby Surround sound.
 - 2 Press NORMAL, PHANTOM or 3 STEREO to select the mode for the speaker configuration.
On the remote control, press SURROUND repeatedly.
 - 3 Press MANUAL SELECT repeatedly on the remote control to select delay time to adjust.
 - C_MS: Delay time setting for center speaker
 - S_MS: Delay time setting for surround speakers
 - 4 Press ◀◀ or ▶▶ to adjust the delay time.
 - For center speaker: Adjust the delay time so that screen dialogs are heard clearly and naturally. Adjust between 0 ms (milliseconds) and 5 ms in 1 ms steps. The default is "C 0MS" (no delay).
 - For surround speakers:
Dolby Digital: Adjust between 0 and 15 ms in 5 ms steps. The default is "S 5MS".
Dolby Pro Logic: Adjust between 15 and 30 ms in 5 ms steps. The default is "S 20MS".
- Adjustment of the delay time setting in Dolby Digital affects that of Dolby Pro Logic, and vice versa. Surround speaker delay time in Dolby Digital of 0 ms, 5 ms, 10 ms and 15 ms, corresponds to 15 ms, 20 ms, 25 ms and 30 ms in Dolby Pro Logic, respectively.
 - Delay time adjustment is available only for speakers that are activated.

Dynamic range adjustment

In Dolby Digital, dynamic range between soft and loud sounds can be adjusted to suit your desired playback volume.

- 1 Play the Dolby Digital sound.
 - 2 Hold down ■■ until "MIDNIGHT THEATER" appears on the display.
 - 3 Press ◀◀ or ▶▶ to select one of the dynamic range modes.
 - MIN: Minimum dynamic range compression. Enjoy the full dynamic range of the sound track as experienced in a movie theater.
 - STD: Standard dynamic range compression recommended by the software producers when playing back at home. Default.
 - MAX: Maximum dynamic range compression. Keeps soft sounds and dialogs intelligible even with the overall volume turned down. Select this mode when you have to keep the volume low, for example, when playing back late at night.
- Dynamic range adjustment is not available for Dolby Pro Logic.

SOUND ADJUSTMENTS

En

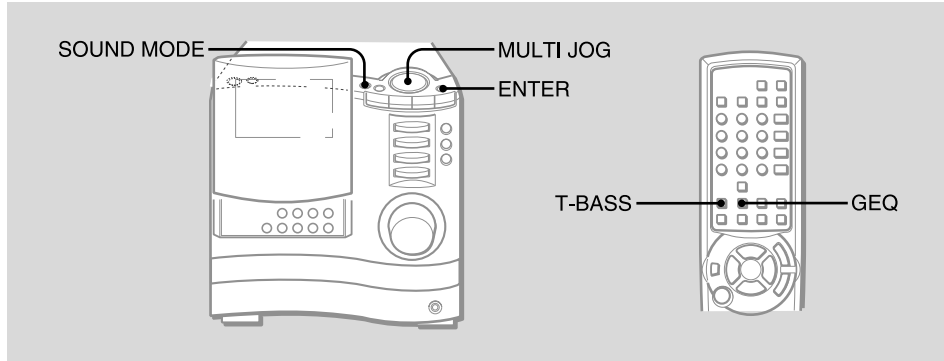

Super T-BASS

Emphasizes low frequencies for a powerful sound.

- 1 Press SOUND MODE once so that "T-BASS" is displayed.
- 2 Turn MULTI JOG to select one of the three emphasis levels or the off position and then press ENTER.
If there is no MULTI JOG operation within 4 seconds, the setting is canceled.

To select with the remote control

Press T-BASS repeatedly to select one of the three levels or the off position.

- When the sound becomes distorted with the T-BASS effect, cancel it.

BBE

Enhances high frequency for sound clarity.

- 1 Press SOUND MODE twice so that "BBE" is displayed.
- 2 Turn MULTI JOG to select one of the three enhancement levels or the off position and then press ENTER.
If there is no MULTI JOG operation within 4 seconds, the setting is canceled.

- When the sound becomes distorted with the BBE effect, cancel it.
- The BBE system cannot be turned on when digital input is selected or Dolby Pro Logic is activated.

Graphic equalizer

Selects a sound equalization curve to match the music type.

- 1 Press SOUND MODE three times so that "GEQ" is displayed.
- 2 Turn MULTI JOG to select one of the five equalization curves and then press ENTER.
If there is no MULTI JOG operation within 4 seconds, the setting is canceled.
 - ROCK: Powerful sound emphasizing treble and bass
 - POP: More presence in the vocals and midrange
 - LATIN: Accented higher frequencies for Latin music.
 - CLASSIC: Enriched sound with heavy bass and fine treble
 - JAZZ: Accented lower frequencies for jazz-type music.

To select with the remote control

Press GEQ repeatedly to select one of the five curves.

To display the current GEQ mode

Press GEQ on the remote control once.
The mode will be displayed for 4 seconds.

To cancel equalization

Repeat step 1 and 2 above and select "GEQ OFF".
On the remote control, press GEQ repeatedly until "GEQ OFF" is displayed.

TIMER OPERATIONS

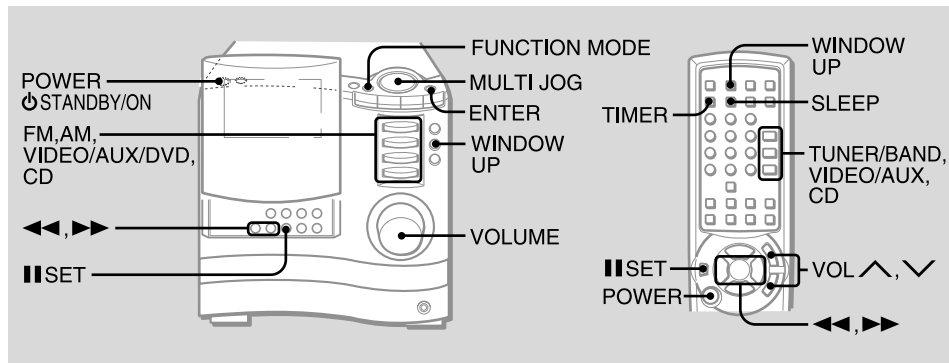

* Move the Window up to reveal the operation buttons with WINDOW UP if needed.

Sleep timer

Turns off the unit automatically after a specified time.

- 1 Press SLEEP on the remote control. "SLP" appears on the display.
- 2 Press ◀◀ or ▶▶ repeatedly to set the sleep timer duration. With each press, the timer duration changes in 5-minute steps between 5 to 240 minutes. If there is no button input for 4 seconds, the current setting is entered automatically. The unit turns off after the selected time.
 - MULTI JOG is also available in place of ◀◀ or ▶▶.

To check the remaining time until the unit turns off

Press SLEEP on the remote control. The remaining time is displayed for 4 seconds.

To cancel the sleep timer

Press SLEEP twice on the remote control so that "SLP OFF" is displayed.

Timer playback

Turns on the unit at a specified time for the specified duration. Make sure the clock is set correctly.

- 1 Press one of the function buttons to select the desired playback source.
- 2 Press FUNCTION MODE repeatedly until "TIMER" is displayed, turn MULTI JOG to select "⊖PLAY" within 4 seconds, and then press ENTER within 4 seconds. "⊖" indicator lights up, and the timer-on time and the source name appear alternately on the display. On the remote control, press TIMER repeatedly until "⊖PLAY" is displayed, and then go to the next step within 6 seconds.
- 3 Press ◀◀ or ▶▶ to set the timer-on time, then press |||SET or ENTER.
 - MULTI JOG is also available in place of ◀◀ or ▶▶.

- 4 Press ◀◀ or ▶▶ to set the timer-activated duration, then press |||SET or ENTER. With each press, the timer-activated duration changes in 5-minute steps between 5 to 240 minutes. If there is no button input for 4 seconds, the current setting is entered automatically.
 - MULTI JOG is also available in place of ◀◀ or ▶▶.

- 5 Adjust the volume and tone for timed playback. If the volume level is set to 21 or higher, it is automatically turned down to 20 when the unit is turned on by the timer.

- 6 Prepare the source.

To play CD(s), load disc(s).

To play the radio, select the band and tune in to the desired station.

To play external equipment connected to the DIGITAL IN (PCM/DOLBY DIGITAL) OPTICAL (VIDEO) jack or the VIDEO/AUX jacks, set an external timer for the equipment so that its playback begins at the same time.

- 7 Press POWER ⏻ STANDBY/ON to turn the unit off. "⊖" remains on the display to indicate the timer standby mode. At timer-on time, the unit turns on and plays the selected source. After the specified timer-activated duration, the unit turns off again.
 - Timer playback will not begin unless the unit is turned off first.
 - Connected equipment cannot be turned on or off by the built-in timer of this unit. Use an external timer.
 - The timer source can be changed with the function buttons before completing step 3.

En

To display the timer setting

Press **TIMER** on the remote control repeatedly until "**⏸PLAY**" is displayed.

The timer-on time, the source and the timer-activated duration are displayed for 6 seconds.

Tip:

Timer setting can be displayed even while the unit is turned off, and at that time if you press **ENTER** or **||** within 6 seconds after **TIMER** on the remote control is pressed, you can enter the timer setting mode and change the setting.

To change the timer setting

Re-set the timer again.

To cancel the timer

Press **FUNCTION MODE** repeatedly until "**TIMER**" is displayed, turn **MULTI JOG** to select "**⏸OFF**" within 4 seconds, and then press **ENTER** within 4 seconds. "**⏸**" disappears from the display.

On the remote control, press **TIMER** repeatedly until "**⏸OFF**" is displayed.

Tip:

Your timer setting is retained even if the timer is canceled. Next time the timer is activated, you can change your previous setting, or simply use the same setting again.

REFERENCE

Care and maintenance

Occasional care and maintenance of the unit and the software are needed to optimize the performance of your unit.

To clean the cabinet

Use a soft and dry cloth. If the unit surfaces are extremely dirty, use a soft cloth lightly moistened with mild detergent solution. Do not use strong solvents such as alcohol, benzine or thinner.

Care of CDs

When a CD becomes dirty, wipe it from the center out with a cleaning cloth. After playing a CD, store it in its case. Do not keep it in hot or humid places.

Troubleshooting

If your unit fails to perform properly, check the following guide and the relevant sections of the Operating Instructions.

There is no sound.

- Are the speakers and AC power cord connected properly?

The unit shut off suddenly.

- Possibly a short circuit in the speaker terminals. Disconnect the AC power cord from the AC power outlet and re-connect the speaker cords correctly.

The unit blacks out when the unit is turned off.

- Is ECO mode set to on?

Erroneous display.

- Reset the unit.

Poor radio reception.

- Check antenna connection. Adjust the antenna to find the best reception.
- Move unit and antenna away from other electric appliances and cords.

The CD player works poorly.

- Is the disc correctly loaded?
- Is the disc dirty?
- Is the lens affected by condensation? If so, wait approximately one hour and try again.

Resetting the unit

If an unusual condition occurs in the display window, reset the unit as follows:

1 Press POWER to turn off the power.

If the power cannot be turned off, disconnect the AC power cord, then plug it in again.

2 Hold down FUNCTION MODE and press POWER.

Everything stored in memory after purchase is cleared.

En

Specifications

MAIN UNIT CX-GDS70

TUNER

FM tuning range	87.5 MHz to 108 MHz
FM usable sensitivity (IHF)	13.2 dBf
FM antenna terminals	75 ohms (unbalanced)
AM tuning range	530 kHz to 1710 kHz (10 kHz step) 531 kHz to 1602 kHz (9 kHz step)
AM usable sensitivity	350 μ V/m
AM antenna	Loop antenna

AMPLIFIER

Power output	Front: 60 W + 60 W (50 Hz - 20 kHz, THD less than 1 %, 8 ohms) 75 W + 75 W (1 kHz, THD less than 10 %, 8 ohms) Rear (Surround): 60 W + 60 W (1 kHz, THD less than 1 %, 8 ohms) 75 W + 75 W (1 kHz, THD less than 10 %, 8 ohms) Center: 60 W (1 kHz, THD less than 1 %, 8 ohms) 75 W (1 kHz, THD less than 10 %, 8 ohms)
Total harmonic distortion	0.1 % (30 W, 1 kHz, 8 ohms, DIN AUDIO/Front)
Inputs	VIDEO/AUX: 300 mV (adjustable) DIGITAL IN (PCM/DOLBY DIGITAL) OPTICAL (VIDEO): Linear PCM signals (32 kHz, 44.1 kHz and 48 kHz) and Dolby Digital bitstream
Outputs	FRONT SPEAKERS: 8 ohms or more SURROUND SPEAKERS: 8 ohms to 16 ohms CENTER SPEAKER: 8 ohms or more SUB WOOFER: 1 V PHONES: 32 ohms or more

CD PLAYER

Laser	Semiconductor laser ($\lambda = 780$ nm)
D/A converter	1 bit dual
Signal-to-noise ratio	85 dB (1 kHz, 0 dB)
Harmonic distortion	0.05 % (1 kHz, 0 dB)

GENERAL

Power requirements	120 V AC, 60 Hz
Power consumption	110 W
Power consumption in standby mode	With ECO mode on: 0.6 W With ECO mode off: 30 W
Dimensions (W x H x D)	260 x 271.5 x 364 mm (10 ¹ / ₄ x 10 ³ / ₄ x 14 ³ / ₈ in.)
Weight	7.5 kg (16 lbs 9 oz)

FIVE SURROUND SPEAKERS SYSTEM SX-GDS70 (FRONT, SURROUND and CENTER SPEAKERS)

Speaker system	1 way (magnetic shielded)
Speaker units	80 mm (3 ¹ / ₄ in.) cone
Impedance	8 ohms
Dimensions (W x H x D)	100 x 220 x 115 mm (4 x 8 ³ / ₄ x 4 ⁵ / ₈ in.) (with pedestal) 100 x 110 x 115 mm (4 x 4 ³ / ₈ x 4 ⁵ / ₈ in.) (without pedestal)
Weight	0.55 kg (1 lbs 3 oz)
Accessories: Wall mounting screws (2)	
*The surround speakers are not magnetic shielded.	

Specifications and external appearance are subject to change without notice.

COPYRIGHT

Check copyright laws relevant to recordings from discs, radio or tape for the country where the unit is to be used.

BBE SYSTEM

The word "BBE" and the "BBE symbol" are trademarks of BBE Sound, Inc.
Under License from BBE Sound, Inc.

DOLBY DIGITAL/DOLBY PRO LOGIC

Manufactured under license from Dolby Laboratories.
"Dolby", "Pro Logic", and the double-D symbol are trademarks of Dolby Laboratories. Confidential unpublished works.
©1992-1997 Dolby Laboratories. All rights reserved.

NOTE

This equipment has been tested and found to comply with the limits for a Class B digital device, pursuant to Part 15 of the FCC Rules. These limits are designed to provide reasonable protection against harmful interference in a residential installation.

This equipment generates, uses, and can radiate radio frequency energy and, if not installed and used in accordance with the instructions, may cause harmful interference to radio communications. However, there is no guarantee that interference will not occur in a particular installation. If this equipment does cause harmful interference to radio or television reception, which can be determined by turning the equipment off and on, the user is encouraged to try to correct the interference by one or more of the following measures:

- Reorient or relocate the receiving antenna.
- Increase the separation between the equipment and receiver.
- Connect the equipment into an outlet on circuit different from that to which the receiver is connected.
- Consult the dealer or an experienced radio/TV technician for help.

CAUTION

Modifications or adjustments to this product, which are not expressly approved by the manufacturer, may void the user's right or authority to operate this product.

For assistance and information
call toll free 1-800-BUY-AIWA
(United States and Puerto Rico)

AIWA CO.,LTD.
 <http://www.aiwa.co.jp>

Printed in Malaysia